

COBRA

MODELS:

AIRMOW 51 PRO (DYM172501)

AIRMOW 51 (DYM162501)

AIRMOW 51B (DYM152501)

COBRA LAWN MOWER OWNER'S MANUAL



Cobra Garden Machinery

Henton and Chattell Ltd., London Road, Nottingham NG2 3HW UK

www.cobragarden.co.uk

! WARNING:

For your own safety please read this manual before attempting to operate your new unit. Failure to follow instructions can result in serious personal injury. Spend a few moments to familiarise yourself with your mower before each use.

1. SYMBOLS MARKED ON THE PRODUCT



Fig. A

B.1 Read Operator's Manual.

B.2 Keep bystanders away.

B.3 Pay attention to the operator's hands and feet to avoid injury.

B.4 Fuel is flammable, keep fire away. Do not add fuel with running machine.

B.5 Toxic fumes; don't operate indoors, including your garage or shed.

B.6 When mowing, please wear protective glasses and ear plugs to defend the operator himself.

B.7 When repairing, please remove the spark plug, before undertaking repair work according to the operational manual.

B.8 Caution: Engine hot.



Figure B: Safety Label Found On the Lawn Mower: KEEP HANDS AND FEET AWAY.

2. GENERAL SAFETY RULES

! WARNING When using petrol tools, basic safety precautions, including the following, should always be followed to reduce the risk of serious personal injury and/or damage to the unit. Read all these instruction before operating this product and retain these instructions for future reference.

! WARNING: This machine produces an electromagnetic field during operation. This field may under some circumstances interfere with active or passive medical implants. To reduce the risk of serious or fatal injury, we recommend persons with medical implants to consult their physician and the medical implant manufacturer before operating this machine.

Training

1. Before using the lawnmower read the instructions carefully. Familiarise yourself with the controls and pay particular attention in learning how to stop the machine in an emergency.
2. Never allow children or people unfamiliar with these instructions to use the lawn mower. Local regulations can restrict

the age of the operator.

3. Never mow while people, especially children or pets are nearby.
4. Never use the mower if the operator is taking medicine or substances that could affect or impair his ability to react or concentrate.
5. Keep in mind that the operator or user is responsible for accidents or hazards occurring to other people or their property.

Before you start

1. While mowing, always wear substantial footwear and long trousers. Do not operate the equipment when barefoot or wearing open toed sandals.
2. Thoroughly inspect the area where the equipment is to be used and remove all objects which can damage or be thrown by the machine.
3. WARNING - Petrol is highly flammable.
 - Store fuel in containers specifically designed for this purpose.
 - Refuel outdoors only and do not smoke while refuelling; add fuel before starting the engine.
 - Never remove the cap of the fuel tank or add petrol while the engine is running or when the engine is hot.
 - If petrol is spilled, do not attempt to start the engine, but move the machine away from the area of spillage and avoid creating any source of ignition until petrol vapours have dissipated.
 - Replace all fuel tank and container caps securely.
4. Replace faulty silencers.
5. Before using, always visually inspect to see that the blade, blade bolts and cutter assembly are not worn or damaged. Replace worn or damaged blades and bolts in sets to preserve balance.

Operation and Caution

1. Do not operate the engine in a confined space where dangerous carbon monoxide fumes can collect, refuel outdoors only.
2. Mow only in daylight or in good artificial light.
3. Avoid operating the equipment in wet grass, where feasible.
4. Always be sure of your footing on slopes.
5. Walk, never run, always be in control of the lawnmower and never allow yourself to be pulled along.
6. For wheeled rotary machines, mow across the face of slopes, never up and down.
7. Exercise extreme caution when changing direction on slopes.
8. Do not mow excessively steep slopes.
9. Use extreme caution when reversing or pulling the lawn mower towards you.
10. Stop the blade if the lawn mower has to be tilted for transportation when crossing surfaces other than grass, and when transporting the lawn mower to and from the area to be mowed
11. Never operate the lawn mower with defective guards, or without safety devices, for example deflectors and/or grass catchers, in place.
12. Do not change the engine governor settings or over speed the engine.
13. Before starting the engine, disengage all blades and drive clutches.
14. Keep your feet well away from the blade when starting the engine and in accordance with the instructions.
15. Do not tilt the lawn mower when starting the engine and always start on a flat surface free from long grass.
16. Do not start the engine when standing in front of the discharge chute.
17. Never put hands or feet near or under rotating parts. Keep clear of the discharge opening at all times.
18. Always ensure the engine is fully switched off before picking up/carrying the Lawnmower.
19. Stop the engine and disconnect the spark plug wire, make sure that all moving parts have come to a complete stop and, where a key is fitted remove the key, make sure engine has had time to cool:
 - Before unclogging chute and clearing blockages.
 - Before checking, cleaning or working on the lawn mower.
 - After striking a foreign object. Inspect the lawnmower for damage and make repairs before restarting.

- If the lawn mower starts to vibrate abnormally (check immediately).
20. Stop the engine and disconnect the spark plug wire, make sure that all moving parts have come to a complete stop and, where a key is fitted remove the key, make sure engine is completely cooled.
- Whenever you leave the lawn mower.
 - Before refuelling.
21. Reduce the throttle setting during engine shut down and, if the engine is provided with a shut-off valve, turn the fuel valve off at the conclusion of mowing.

Maintenance and Storage

1. Keep all nuts, bolts and screws tight to be sure the equipment is in safe working condition.
2. Never store the equipment with petrol in the tank inside a building where fuel vapours can reach an open flame or spark or where the temperature is high.
3. Before storage allow the engine to cool.
4. To reduce the fire hazard, keep the engine, silencer, battery compartment and petrol storage area free of grass, leaves, or excessive grease.
5. Replace worn or damaged parts for safety. Genuine parts should always be used as parts of inferior quality can damage the equipment and compromise safety.
6. If the fuel tank has to be drained, this should be done outdoors. Always ensure engine is completely cooled before starting this task.
7. If the blade needs to be removed, wear strong gloves to prevent injury to hands and fingers. Check the blades balance after sharpening.
8. When transporting the machine make sure you close the fuel cut off. Be careful to ensure weight is evenly distributed. Wear strong gloves.
9. When tilting the machine never tilt towards the air filter as this may become damaged with fuel.
10. Never crank the engine when the spark plug is removed.
11. Frequently check the fuel lines and fittings for damage and cracks, replace if necessary
12. Never start the engine with the air filter cover removed.

Fertilisers and top dressings are particularly corrosive.

15. In time your chassis may peel because of the abrasive action of the debris making contact. This can be remedied by touching up paintwork where necessary to prevent corrosion.

Slope Operation

1. Operating machinery on slopes requires extra care to avoid slips, falls and other accidents.
2. Only mow slopes when it is safe to do so.
3. Mow across slopes. Do not mow up and down. Apply extra care when changing direction.
4. Uneven ground can cause slips and fall accidents. Check the area to be mown before for rocks, bumps, holes, hidden objects and ruts before proceeding.
5. Do not mow when conditions are wet or the slope is slippery.
6. Do not mow excessively steep slopes, always make sure you are sure footed.
7. Do not mow near drop off edges, cliffs, ditches or steep embankments.
8. Never restrict the operating presence control from operating correctly.
9. Always securely hold the upper handle with two hands.



Warning: Do not touch rotating blade.



Warning: Refuel in a well ventilated area with the engine stopped.

CONTENTS

SECTION 1	SYMBOLS MARKED ON THE PRODUCT.....	2
SECTION 2	GENERAL SAFETY RULES.....	2
SECTION 3	PARTS DESCRIPTION.....	6
SECTION 4	TECHNICAL DATA.....	6
SECTION 5	ASSEMBLY.....	7
SECTION 6	OPERATION INSTRUCTIONS.....	11
SECTION 7	MAINTENANCE INSTRUCTIONS	14
SECTION 8	LUBRICATION INSTRUCTIONS	14
SECTION 9	CLEANING.....	14
SECTION 10	STORAGE INSTRUCTIONS (OFF SEASON).....	17
SECTION 11	TROUBLE SHOOTING GUIDE.....	18
SECTION 12	WARRANTY.....	19
SECTION 13	ENVIRONMENT.....	19
SECTION 14	EC-DECLARATION OF CONFORMITY.....	20

3. PARTS DESCRIPTION



Fig.1



- | | | | |
|-------------------------|-----------------|------------------|-----------------------------|
| 1. Brake control handle | 2. Upper handle | 3. Choke Lever | 4. Middle Handle (Optional) |
| 5. Wiring connector | 6. Wheel frame | 7. Wheel | 8. Cable clamp |
| 9. Hook | 10. Oil Cap | 11. Deck | 12. Fuel cap |
| 13. Starter handle | 14. Spark plug | 15. Lower handle | 16. Locking knob |

Please note: The Airmow 51B has an automatic choke and does not require a choke lever.

Including

A: Spark plug wrench

4. TECHNICAL DATA

Model	AIRMOW51PRO (DYM172501)	AIRMOW 51 (DYM162501)	AIRMOW 51B (DYM152501)
Engine type	Honda GCV160	Cobra DG350	B&S 575EX
Engine Displacement	160 cm ³	98.5 cm ³	140 cm ³
Nominal Power	2.8kW	1.9kW	2.2kW
Blade Width	510mm	510mm	510mm
Rated Speed	3000/min	3000/min	3000/min
Fuel Tank Capacity	0.91L	0.8L	0.8L
Net Weight	23.5kg	22.0kg	19.8kg
Height adjustment	17~25mm, 2 adjustments	17-25mm 2 adjustments	17-25mm 2 adjustments
Guaranteed Sound pressure level at the operator's position (According to EN ISO 5395-1 Annex F & EN ISO 5395-2, EN ISO 4871)	83.2 dB(A) K=3dB(A)	87.5 dB(A) (K=3dB(A))	81.5dB(A) (K=3dB(A))
Measured sound power level Guaranteed Sound Power level (According to 2000/14/EC)	96.04dB(A) K=1.02dB(A) 98 dB(A)	96.37dB(A) K=0.88dB(A) 98 dB(A)	95.99dB(A) K=1.23dB(A) 98 dB(A)
Vibration (According to EN ISO 5395-1 Annex G & EN ISO 5395-2)	Max.3.471m/s ² K=1.5 m/s ²	Max.3.378m/s ² K=1.5 m/s ²	Max.3.990m/s ² K=1.5 m/s ²

5. ASSEMBLY

STANADRD HANDLE

5.1 LOWER HANDLE

1. Feed the hook attached to the lower handle halfway through the centre slot of the guide, fix the hook into the lower handle with a suitable spanner. (Fig. 2A)
2. Maintaining the hook in the centre slot of the guide turn the lower handle clockwise to place both legs of the lower handle in position between the hood brackets. (Fig. 2B)
3. Fix the lower handle into the unit body with bolt, pin and locking knob. (Fig. 2C/2D/2E)
4. Lifting the hook to the 'parking' position. (Fig. 2F)

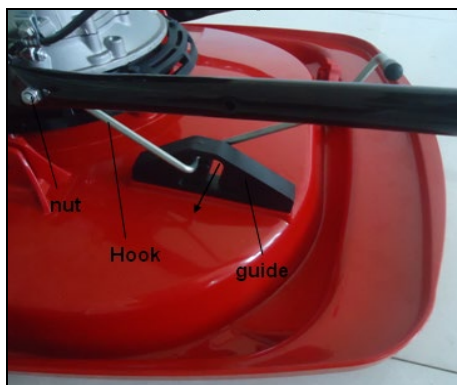

Fig. 2A



Fig. 2B

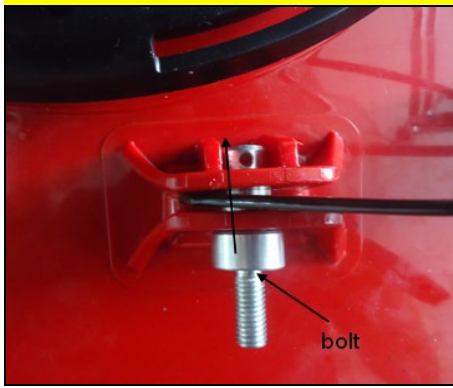

Fig. 2C

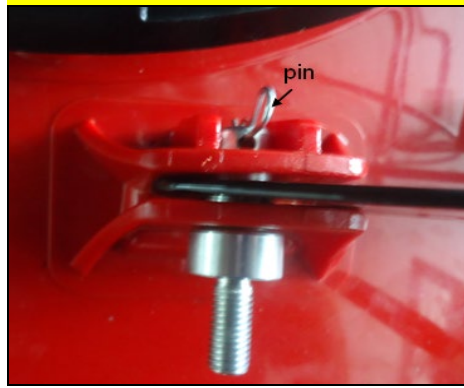

Fig. 2D

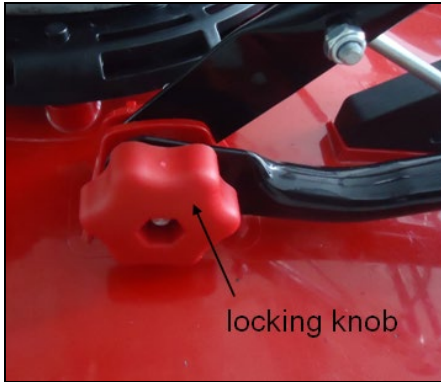

Fig. 2E



Fig. 2F

5.2 TRANSPORT WHEELS (OPTION)

1. Remove the locking knob. (Fig. 2G)
2. Fix the wheel frame into the unit body with the bolt and locking knob (Fig. 2H)
3. Loosen the locking knob for folding, and open the locking device with the press the button. (Fig. 2 I)
4. Fix the wheel frame into the lower handle and tightening locking knob. (Fig. 2J)



Fig.2G



Fig.2H



Fig.2I



Fig.2J

5.3 UPPER HANDLE

1. Fix the upper handle and the lower handle with the bolt, washer and locking knob. (Fig. 2K)
2. Connect the upper brake control wire (1) and lower brake control wire with wiring connector. (Fig. 2L)
3. Fix the upper brake control wire into brake control handle. (Fig. 2M)
4. Fix brake control handle into upper handle. (Fig. 2N)

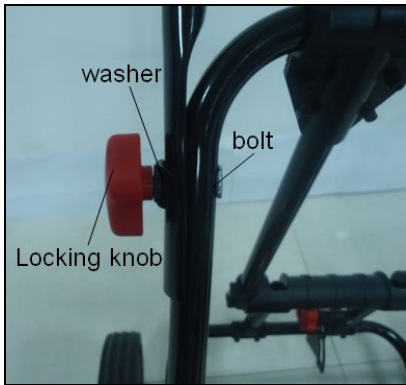

Fig.2K

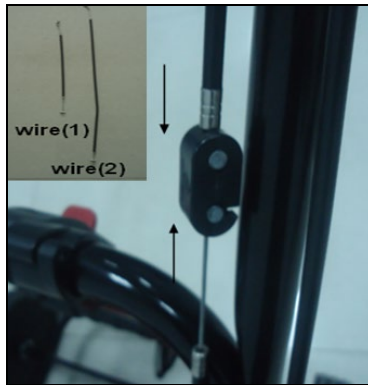

Fig.2L



Fig.2M



Fig.2N

EXTENDED REACH MIDDLE HANDLE (OPTION)

5.4 LOWER HANDLE AND WHEELS

Fix lower handle and wheels same as section 5.1 and 5.2.

5.5 MIDDLE HANDLE

Fix the middle handle and the lower handle with the bolt, washer and locking knob. (Fig. 2O)

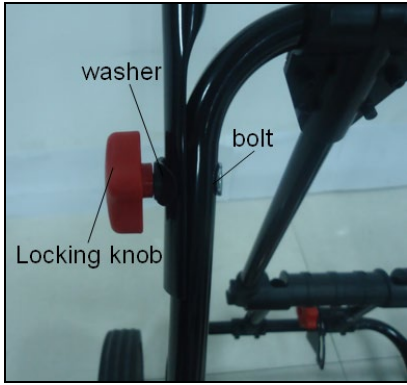

Fig.20

5.6 UPPER HANDLE

1. Remove the choke lever from the position (1) of upper handle, and fix the choke lever into the position (2) bolt, washer and nut. (Fig. 2P/Q/R)
2. Connect the upper brake control wire (2) and lower brake control wire with wiring connector. (Fig. 2L)
3. Fix the upper brake control wire into brake control handle. (Fig. 2M)
4. Fix brake control handle into the upper handle. (Fig. 2N)

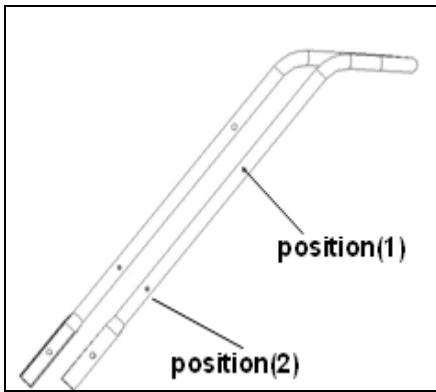

Fig.2P

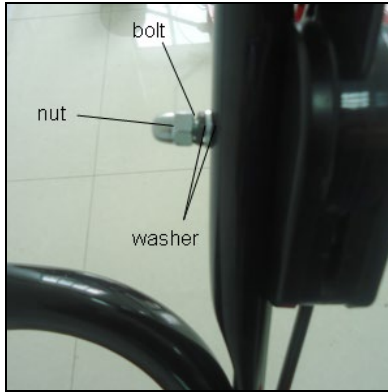

Fig.2Q



Fig.2R

5.7 HEIGHT OF CUT

AIRMOW 51 PRO ONLY - Reduce or add a washer to adjust height. (Fig. 3)

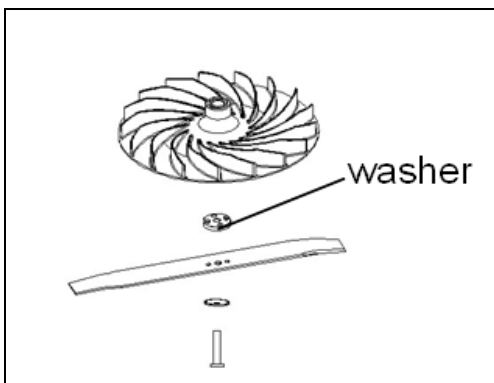

MAXIMUM 1 SPACER TO LOWER THE HEIGHT OF CUT

Fig. 3

Center Bolt should be tightened to 35Nm-45Nm, to insure safe operation of your unit. ALL nuts and bolts must be checked periodically for correct tightness.

 **WARNING!**

Never use more than 1 cutting height washer/spacer.

The washer/spacer can only be fitted between the blade and the fan and never between blade and the bolt. Do not use the washer/spacer in long grass conditions.

6. OPERATING INSTRUCTIONS

6.1 BEFORE STARTING

Service the engine with petrol and oil as instructed in the separate engine manual packed in your mower. Read instructions carefully.

ALWAYS CHECK THE OIL LEVEL BEFORE STARTING – INSUFFICIENT OIL WILL DAMAGE THE ENGINE

 **WARNING!** Petrol is highly flammable.

Store fuel in containers specifically designed for this purpose.

Refuel outdoors only, before starting the engine and do not smoke while refueling or handling fuel.

Never remove the cap of the fuel tank or add petrol while the engine is running or when the engine is hot.

If petrol is spilled, do not attempt to start the engine but move the machine away from the area of spillage and avoid creating any source of ignition until petrol vapors have dissipated.

Replace all fuel tanks and container caps securely.

Before tipping the lawn mower to maintain the blade or drain oil, remove fuel from the tank.

 **WARNING:** never fill fuel tank indoors, with engine running or until the engine has been allowed to cool for at least 15 minutes after running.

6.2 TO START ENGINE AND ENGAGE BLADE

1. Loosen the locking knob, fold the wheel frame and tighten the locking knob, or remove the wheel frame. (Fig.4A)

2. Lifting the hook to the 'mowing' position. (Fig.4B)

3. Before starting the engine, on the AIRMOW 51 PRO only, please turn the fuel switch to the  position,

All models except 51B: Turn the choke lever to  position. (Fig.4C/D/F)

Please note: The Airmow 51B has an automatic choke.

4. Place your right foot firmly on the deck, grasp the brake control handle and hold it against the upper handle. (Fig.4E)

5. Grasp the starter handle and pull up rapidly. Return it slowly to the rope guide bolt after the engine starts.

Release the brake control handle to stop the engine and blade. (Fig.4E)

6. **AIRMOW 51 PRO:** After starting the engine, turn the throttle choke lever to  position for normal mowing. (Fig.4D).

And turn throttle choke lever to  to slow the engine (Fig.4D).

AIRMOW 51: After starting the engine, turn the throttle choke lever to  position for normal mowing. (Fig.4F).

And turn throttle choke lever to  for slow the engine (Fig.4F).



Fig. 4A

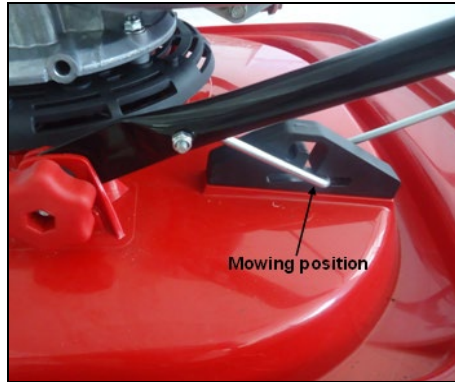

Fig. 4B



Fig.4C



Fig.4D



Fig.4E



Fig. 4F

⚠ Start the engine carefully according to instructions and with feet well away from the blade.

⚠ Do not tilt the lawn mower when starting the engine. Start the mower on a level surface, free of high grass or obstacles.

⚠ Keep hands and feet away from the rotating parts.

6.3 HOW TO MOW

Warning!

Before using the lawnmower, always visually inspect to see that blades and bolts are not worn or damaged.

1. Lifting the hook to the 'mowing' position. (Fig.4B)
2. Mow twice a week in the growing season. Your lawn will suffer if more than one third of its length is cut at one time.

Keep hands and feet away from the blade, a rotating blade cannot be seen.

Mowing on banks and slopes can be dangerous. Do not mow on steep slopes.

Always keep your feet on flat ground with the mower below you on the slope.

Do not use this mower on slopes which are wet or more than 45° from the horizontal.

Never push the mower up the slope.

WITH THE AIRMOW 51 PRO: Keep the spark plug uppermost to avoid lubricating oil running into the cylinder.

6.4 TO STOP THE ENGINE

1. Release the brake control handle to stop the engine and blade. (Fig.5A).

2. Disconnect and ground the spark plug wire as instructed in the separate engine manual to prevent accidental starting while equipment is unattended.



3. AIRMOW 51 PRO: Turn the fuel switch to the "off" position. (Fig.5B).

4. Lifting the hook to the 'parking' position. (Fig.5C).

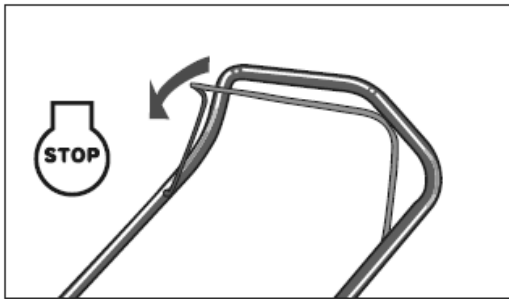

Fig.5A

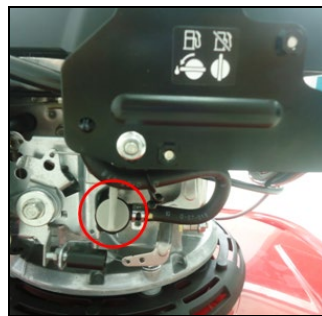

Fig.5B



Fig.5C

⚠ CAUTION: The blade continues to rotate for a few seconds after the engine is shut off.

6.5 FOR THE BEST RESULTS WHEN MOWING

Clear the lawn of debris. Be sure that the lawn is clear of stones, sticks, wire or other foreign objects which could be accidentally thrown out by the mower in any direction and cause serious personal injury to the operator and others as well as damage to property and surrounding objects.

Do not cut wet grass. For effective mowing do not cut wet grass because it tends to stick to the underside of the deck preventing proper mowing of the grass clippings. Cut no more than 1/3 the length of the grass. The recommended cut for mowing is 1/3 the length of the grass. Ground speed will need to be adjusted so the clippings can be dispersed evenly into the lawn. For especially heavy cutting in thick grass it may be necessary to mow at a slower pace in order to get a clean well mowed cut. When mowing long grass you may have to cut the lawn in two passes, lowering the blade another 1/3 of the length for the second cut and perhaps cutting in a different pattern than was used the first time. Overlapping the cut a little on each pass will also help to clean up any stray clippings left on the lawn. The mower should always be operated at full throttle to get the best cut and allow it to do the most effective job of mowing.

Clean the underside of deck. Be certain to clean the underside of the cutting deck after each use to avoid a build-up of grass, which would prevent proper mulching and dispersal.

 **WARNING:** If you strike a foreign object, stop the engine. Remove the wire from spark plug, thoroughly inspect the mower for any damage and repair the damage before restarting and operating the mower. Extensive vibration of the mower during operation is an indication of damage. The unit should be promptly inspected and repaired.

6.6 DECK

The underside of the mower deck should be cleaned after each use to prevent a buildup of grass clippings, leaves, dirt or other matter. If this debris is allowed to accumulate, it will invite rust and corrosion, and may prevent proper mulching. The deck may be cleaned, with the engine stopped by tilting the mower and scraping clean with a suitable tool (make certain the spark plug wire is disconnected).

7. MAINTENANCE INSTRUCTIONS

SPARK PLUG

Use only original replacement spark plug. For best results, replace the spark plug every 100 hours of use.

BRAKE PADS

Regularly check and/or replace the engine brake pads when completing service work, only original parts can be used as replacements.

8. LUBRICATION INSTRUCTIONS

 **CAUTION:** DISCONNECT SPARK PLUG BEFORE SERVICING.

1. WHEELS-Lubricate the ball bearings in each wheel at least once a season with a light oil.
2. ENGINE-Follow the engine manual for lubrication instructions.

9. CLEANING

 **CAUTION:** Do not hose the engine. Water can damage engine or contaminate the fuel system.

1. Wipe the deck with a dry cloth.
2. Hose under deck by tilting the mower so that the spark plug is up. ENGINE MUST BE STOPPED

9.1 ENGINE AIR CLEANER

⚠ CAUTION: Do not allow dirt or dust to clog the air filter foam element. The engine air cleaner element must be serviced (cleaned) after 25 hours normal mowing. The foam element must be serviced regularly if the mower is used in dry dusty conditions.

To CLEAN AIR FILTER

1. Press down the two tabs on top of the filter cover.
2. Remove cover.
3. For foam elements: Wash filter element in soap water. **DO NOT USE GASOLINE!**
4. Air dry filter element.
5. Place a few drops of SAE30 oil on the foam filter and squeeze tightly to remove any excess oil.
6. Reinstall filter.
7. Cartridge or paper filters should be replaced rather than cleaned.

NOTE: Replace the filter if frayed, torn, damaged or unable to be cleaned.

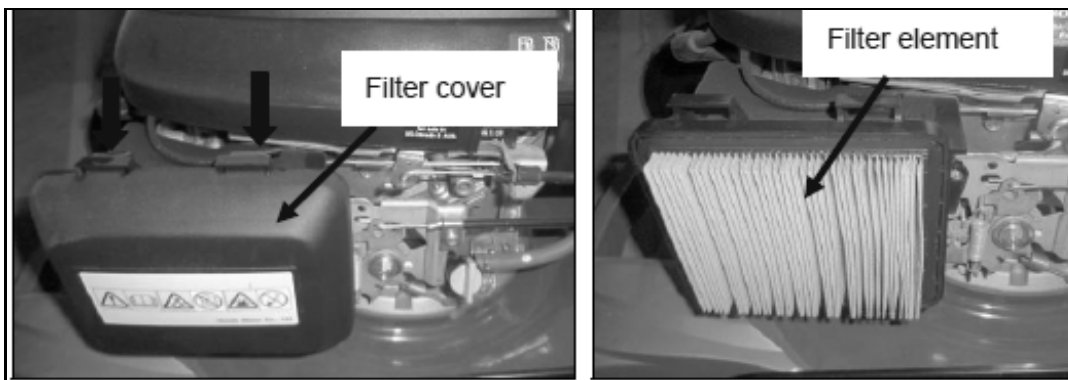

Fig.6A

Fig.6B

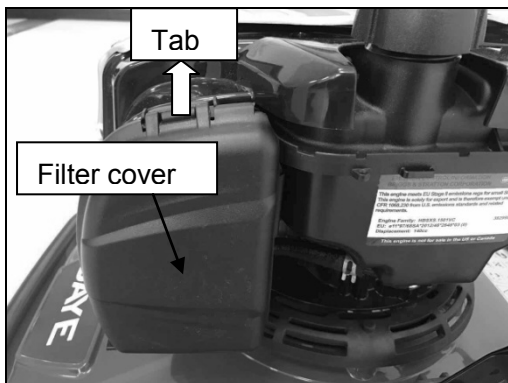

Fig.6C AIRMOW 51B

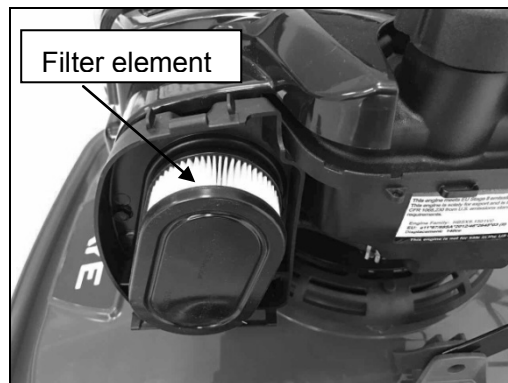

Fig.6D

9.2 CUTTING BLADE

⚠ CAUTION: Be sure to disconnect and ground the spark plug wire before working on the cutting blade to prevent accidental engine starting. Protect hands by using heavy gloves or a rag to grasp the cutting blade. Tip mower as specified in separate engine manual. Remove the hex bolt and washer which hold the blade and blade adapter to the engine crankshaft. Remove the blade and adapter from the crankshaft.

⚠ WARNING: Periodically inspect the blade adapter and fan for cracks, especially if you strike a foreign object. Replace when necessary.

For best results your blade should be sharp. The blade may be resharpened by removing it and either grinding or filing the cutting edge keeping as close to the original bevel as possible. It is extremely important that each cutting edge receives an equal amount of grinding to prevent an unbalanced blade. Improper blade balance will result in excessive vibration causing eventual damage to the engine and mower. Be sure to carefully balance the blade after sharpening. The blade can be tested for balance by balancing it on a round shaft screwdriver. Remove metal from the heavy side until it balances evenly.

Before reassembling the blade and the blade adapter to the unit, lubricate the engine crankshaft and the inner surface of the blade adapter with light oil. Insert the key into the blade adapter and Install the blade adapter on the engine crankshaft, push the washer into the blade adapter and install the blade, Refer to figure 7. Place the blade with the part number facing away from the adapter. Align the washer over the blade and insert the hex bolt. Tighten the hex bolt to the torque listed below:

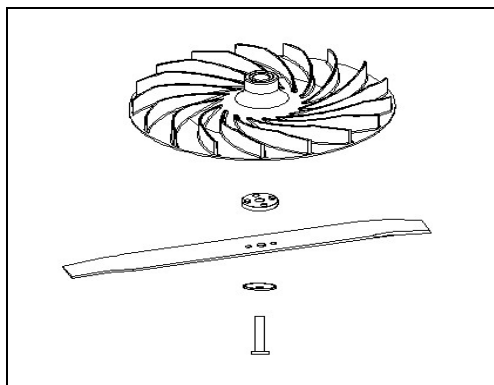

Fitted with 1 spacer for a lower cut.

Fig.7

9.3 BLADE MOUNTING TORQUE

Center Bolt 35Nm-45Nm, to insure safe operation of your unit. ALL nuts and bolts must be checked periodically for correct tightness.

After prolonged use, especially in sandy soil conditions, the blade will become worn and lose some of the original shape. Cutting efficiently will be reduced and the blade should be replaced. Replace with an approved factory replacement blade only. Possible damage resulting from blade unbalance condition is not the responsibility of the manufacturer.

When you change the blade, you must use the original type marked on the blade (Cobra 263003470) (For order the blade, please contact your local dealer or call Cobra.)

9.4 ENGINE

Refer to the separate engine manual for engine maintenance instructions.

Maintain engine oil as instructed in the separate engine manual packed with your unit. Read and follow instructions carefully.

Service the air cleaner as per separate engine manual under normal conditions. Clean every few hours under extremely dusty conditions. Poor engine performance and flooding usually indicates that the air cleaner should be serviced.

To service the air cleaner, refer to the separate engine manual packed with your unit.

The spark plug should be cleaned and the gap reset once a season. Spark plug replacement is recommended at the start of each mowing season; check engine manual for correct plug type and gap specifications.

Clean the engine regularly with a cloth or brush. Keep the cooling system (blower housing area) clean to permit proper air circulation which is essential to engine performance and life. Be certain to remove all grass, dirt and combustible debris from muffler area.

10. STORAGE INSTRUCTIONS (OFF SEASON)

The following steps should be taken to prepare the lawn mower for storage.

1. Empty the tank after the last mowing of the season.

a) Empty the petrol tank with a suction pump.



CAUTION! Do not drain the petrol in closed rooms, in close proximity of open fire, etc. Do not smoke! Petrol fumes can cause an explosion or fire.

b) Start the engine and let it run until it has used up all remaining petrol and stalls.

c) Remove the spark plug. Use an oilcan to fill approximately 20 ml oil into the combustion chamber. Operate the starter to evenly distribute the oil in the combustion chamber. Replace the spark plug.

2. Clean and grease the lawnmower carefully as described above under "Lubrication".

3. Slightly grease the cutter to avoid corrosion.

4. Store the lawnmower in a dry, clean and frost-protected place, out of reach of unauthorized persons.



CAUTION! The engine must have completely cooled down before storing the lawnmower.



NOTE:

- When storing any type of power equipment in an unventilated or storage shed, care should be taken to rust-proof the equipment. Using a light oil or silicone, coat the equipment, especially cables and all moving parts.

- Be careful not to bend or kink cables.

- If the starter rope becomes disconnected from rope guide on the handle, disconnect and ground the spark plug wire, depress the blade control handle and pull the starter rope out from engine slowly. Slip the starter rope into the rope guide bolt on the handle.

Transport

Turn the engine off and allow the engine to cool down. Then disconnect the spark plug wire and empty the fuel tank according to the instructions in the engine manual. Ensure not to bend or damage the cutter when pushing the lawnmower over obstacles.

11. TROUBLES SHOOTING

PROBLEM	PROBABLE CAUSE	CORRECTIVE ACTION
Engine does not start.	Throttle choke not in the correct position for the prevailing conditions.	Move throttle choke to the correct position
	Fuel tank is empty.	Fill tank with fuel: refer to ENGINE OWNERS MANUAL.
	Air cleaner element is dirty.	Clean the air cleaner element: refer to ENGINE OWNERS MANUAL
	Spark plug loose.	Tighten the spark plug: refer to ENGINE OWNERS MANUAL
	Spark plug wire loose or disconnected from the plug.	Install the spark plug wire on spark plug.
	Spark plug gap is incorrect.	Set the gap between the electrodes: refer to ENGINE OWNERS MANUAL
	Spark plug is defective	Install a new, correctly gapped plug: refer to ENGINE OWNERS MANUAL
	Carburetor is flooded with fuel	Remove the air cleaner element and pull starter rope continuously until carburetor clears itself and install the air cleaner element.
	Faulty ignition module	Contact the service agent.
Engine difficult to start or loses power.	Dirt, water, or stale fuel in the tank.	Drain fuel and clean the tank. Fill the tank with clean, fresh fuel
	Vent hole in fuel tank cap is plugged.	Clean or replace the fuel tank cap.
	Air cleaner element is dirty.	Clean the air cleaner element.
Engine operates erratically.	Spark plug is defective.	Install a new, correctly gapped plug: refer to ENGINE OWNERS MANUAL
	Spark plug gap is incorrect.	Set the gap between electrodes: refer to ENGINE OWNERS MANUAL
	Air cleaner element is dirty.	Clean the air cleaner element: refer to ENGINE OWNERS MANUAL
Engine idles poorly.	Air cleaner element is dirty.	Clean the air cleaner element: refer to ENGINE OWNERS MANUAL
	Air slots in engine shroud are blocked.	Remove debris from the slots.
	Cooling fins and air passages under engine blower housing are blocked.	Remove debris from the cooling fins and air passages.
Engine skips at high speed.	Gap between electrodes of spark plug is too close.	Set the gap between electrodes: refer to ENGINE OWNERS MANUAL
Engine overheats	Cooling air flow is restricted.	Remove any debris from the slots in shroud, blower housing, air passages
	Incorrect spark plug.	Refer to ENGINE OWNERS MANUAL.
Mower vibrates abnormally	Cutting assembly is loose.	Tighten blade
	Cutting assembly is unbalanced	Balance blade.

12. WARRANTY

This product is warranted in accordance with legal regulations for a 24month period effective from the date of purchase by the first user.

This product will not be covered if used in a commercial application.

This warranty covers all material or production failures, it does not include: defects from normal wear and tear, parts such as, bearings, brushes, cables, air cleaning elements, brake pad, clutch disc, tyre, wheel, recoil starter rope, belts, cutter blades, plugs, lubricant oils and grease or accessories. Damage or defects resulting from abuse, accidents or alterations, natural fading of painted or plated surfaces, sheet peeling and other natural deterioration.

Any damage that occurs from the use of non-genuine Cobra parts will not be covered.

We reserve the right to reject any claim where the purchase cannot be verified or when it is clear that the product was not maintained properly. (Clean ventilation slots, carbon brushes and serviced regularly)

Expenses incidental to the warranty claim that are not covered;

-Compensation for loss of time, commercial loss or rental costs of substitute product.

-Costs incurred for transportation to and from the dealership.

Any damage that occurs from the following will not be covered; exposure of the product to smoke and soot, chemical agents, bird droppings or other animal waste, seawater, sea breeze, salt or other environmental phenomena.

Any damage resulting from operating methods other than those indicated in the owner's manual will not be covered.

Your purchase receipt must be kept as proof for date of purchase. Your un-dismantled mower must be returned to your dealer in an acceptably clean state, accompanied by your proof of purchase.

Please Register Your Mower

If your dealer did not collect registration information from you, please take a few minutes and register your purchase with Cobra.

You can register by completing and mailing the registration card that should be in the box or by going online to:

www.cobragarden.co.uk and clicking on Product Registration.

Before using the lawn mower, all mower operators must read this manual

13. ENVIRONMENT

Should your machine need replacement after extended use, do not put it in the domestic waste but dispose of it in an environmentally safe way.

14. EC-DECLARATION OF CONFORMITY

EC Declaration of Conformity			
We herewith declare,	Cobra Garden Machinery Henton & Chattell Ltd, London Road, Nottingham NG2 3HW United Kingdom		
That the following machine complies with the appropriate basic safety and health requirements of the EC Directive based on its design and type, as brought into circulation by us.			
In case of alteration of the machine, not agreed upon by us, this declaration will lose its validity			
Machine Description:	Petrol Lawn mower		
Machine Type:	AIRMOW 51 PRO (DYM172501)	AIRMOW 51 (DYM162501)	AIRMOW 51B (DYM152501)
Displacement	160cm ³	98.5cm ³	140cm ³
Max. Cutting length:	510mm	510mm	510mm
Measured sound power level:	96.04dB(A)	96.37dB(A)	95.99dB(A)
Guaranteed sound power level:	98dB(A)	98dB(A)	98dB(A)
	Notified Body for EC Directive 2000/14/EC:0499 TÜV Rheinland LGA Products GmbH Tillystrasse 2, 90431 Nürnberg, Germany 0197		
Applicable EC Directives:	2006/42/EC	2014/30/EU	2000/14/EC 97/68/EC
Applicable Harmonized Standards:	EN ISO 5395-1 EN ISO 5395-2 EN ISO 14982		
Authorized Signature/Date/ Place:	 Peter J. Chaloner 10/06/2017		
Title of Signatory:	Managing Director		
Name and address of the person authorised to compile the technical file	Cobra Garden Machinery Henton & Chattell Ltd, London Road, Nottingham NG2 3HW United Kingdom		